

PLAN

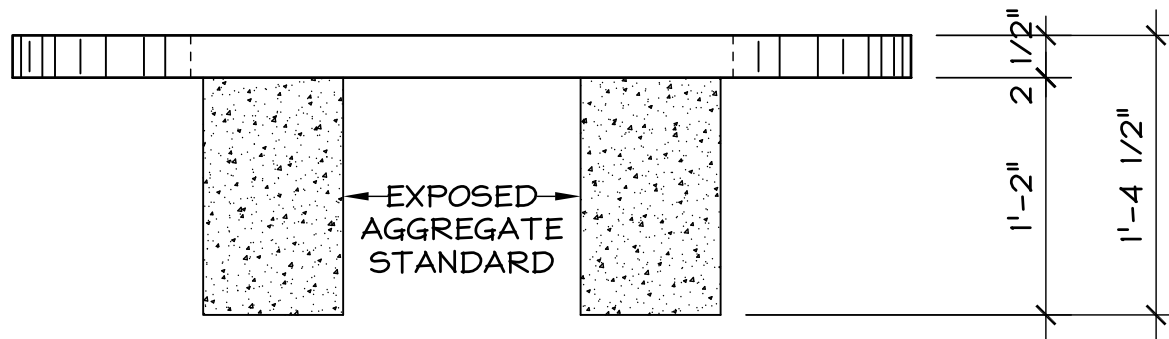

ELEVATION

WEIGHT: 235#

CONCRETE SPECIFICATIONS

4000 28-DAY COMPRESSIVE STRENGTH

4-7% ENTRAINED AIR
MILD STEEL REINFORCING AS REQUIRED
POLY PROPYLENE FIBER SECONDAR
REINFORCING

FORMS

SMOOTH SURFACE FIBERGLASS

COLORS

GREY, BUFF, OR INTEGRAL COLOR

STANDARD FINISH

SMOOTH TOP
EXPOSED AGGREGATE PEDESTAL
COLORED CONCRETE: COLOR SEAL TOP
CLEAR SEALER

CIMARRON
BENCH

BN-0036

ARCHITECTURAL PRECAST CONCRETE
MATERIALS, INC.

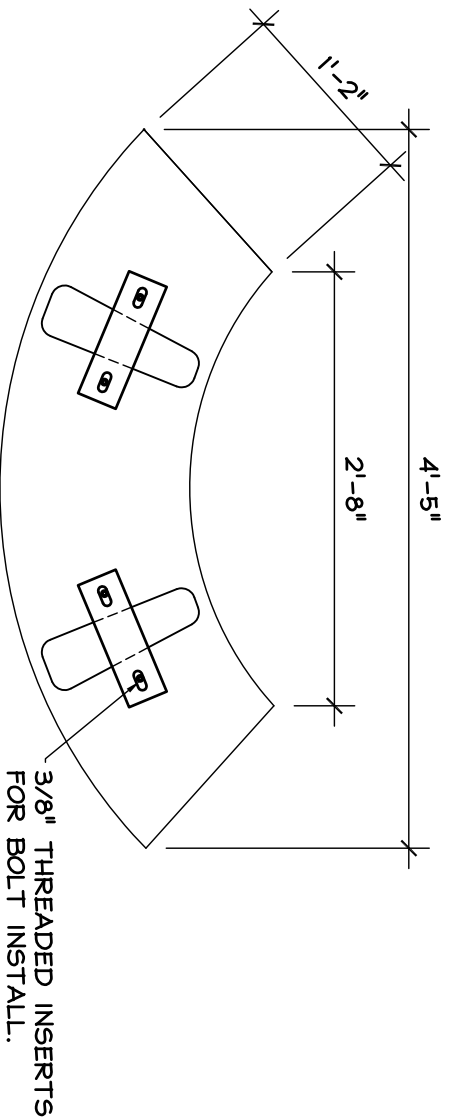

BOTTOM PLAN

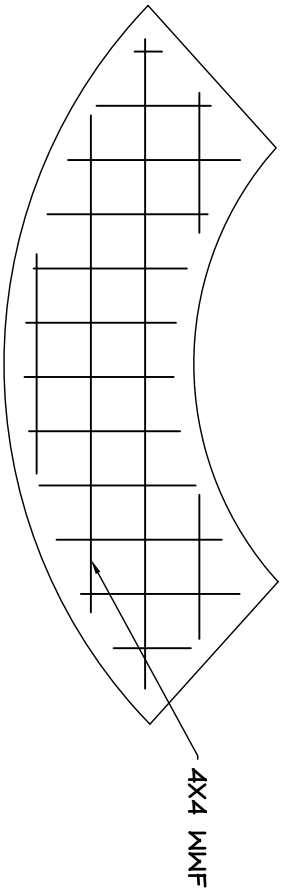

REINFORCING

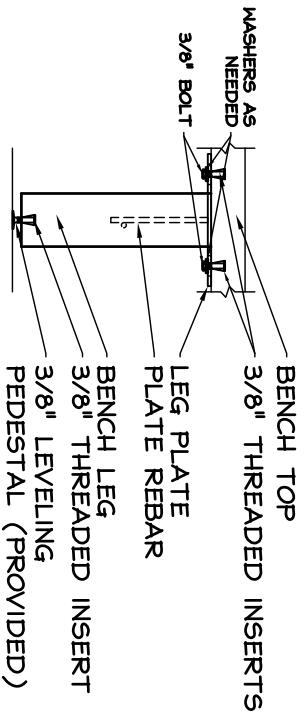

LEG TO BENCH/LEVELLING

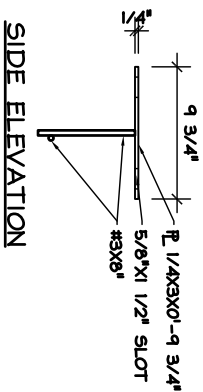
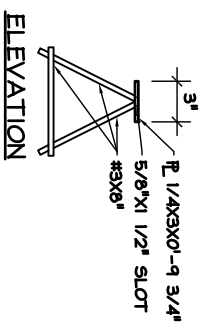
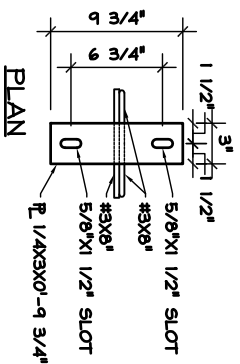

LEG PLATE DETAIL

WEIGHT: 235#

CONCRETE SPECIFICATIONS

4000 f'c 28-DAY COMPRESSIVE STRENGTH
 4-7% ENTRAINED AIR
 MILD STEEL REINFORCING AS REQUIRED
 POLY PROPYLENE FIBER SECONDARY REINFORCING

FORMS

SMOOTH SURFACE FIBERGLASS

COLORS

GREY OR INTEGRAL COLOR (COHILLS COLOR PIGMENTS AVAILABLE)

STANDARD FINISH

SMOOTH TOP
 EXPOSED AGGREGATE LEGS
 COLORED CONCRETE: COLOR SEAL TOP CLEAR SEALER

CIMARRON
 BENCH

BN-0036

ARCHITECTURAL PRECAST CONCRETE
MATERIALS, INC.